

LOCINOX[®]

WWW.LOCINOX.COM

CODE: BEARING HINGE

① OVERVIEW

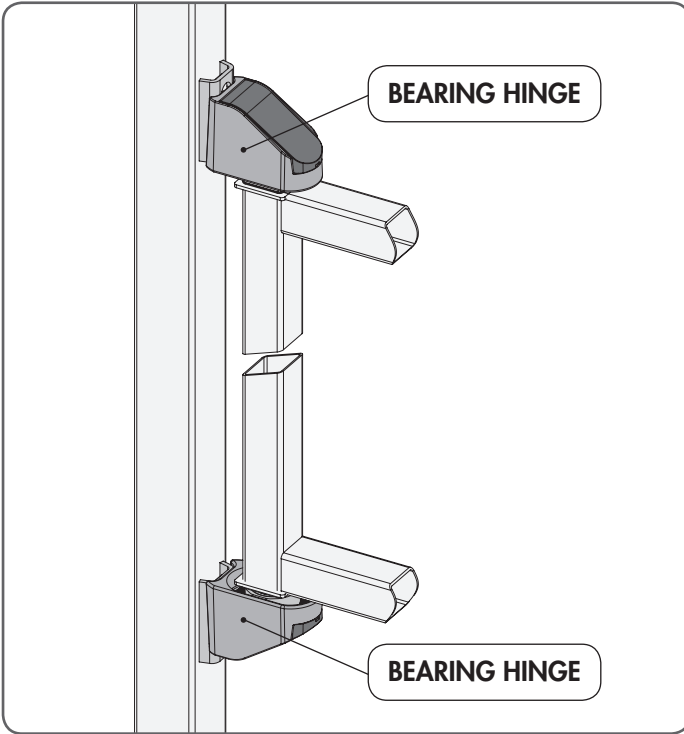

② EXPLOSION

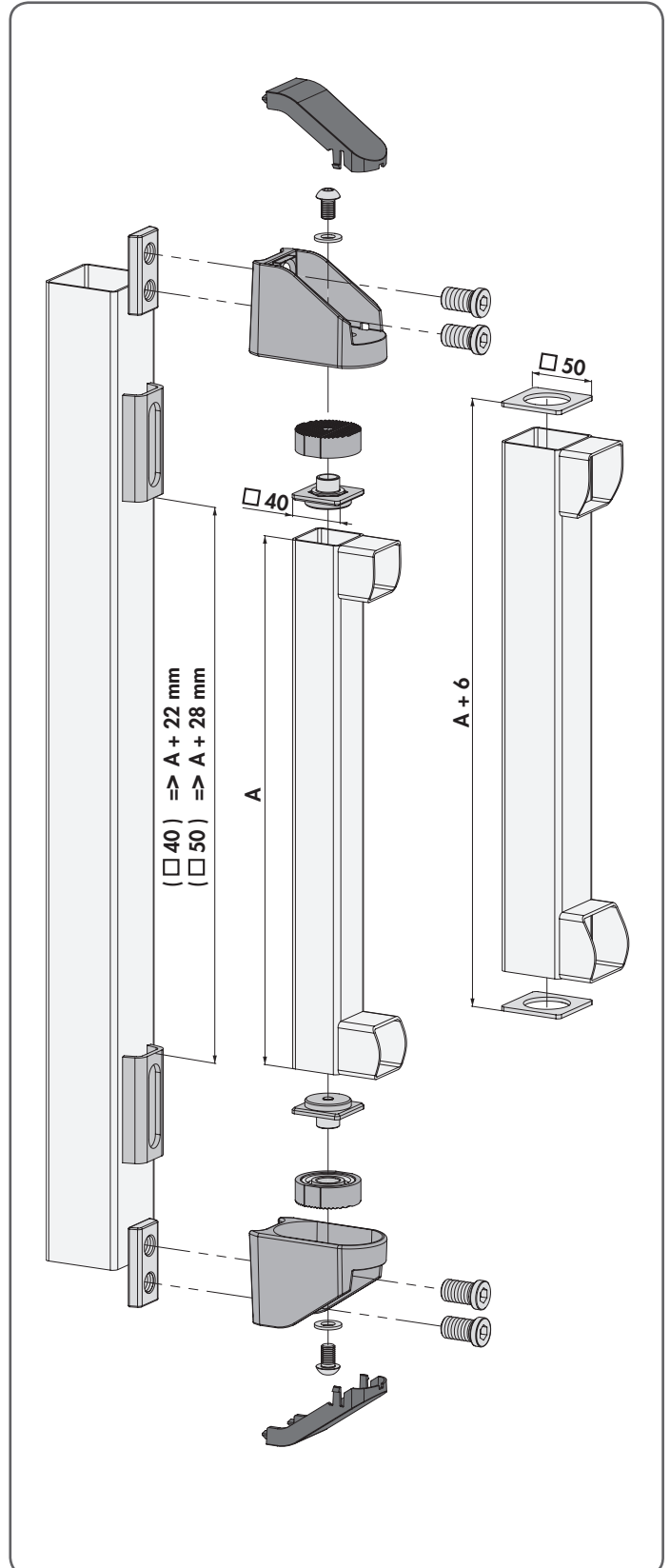

③ FEATURES & DIMENSIONS

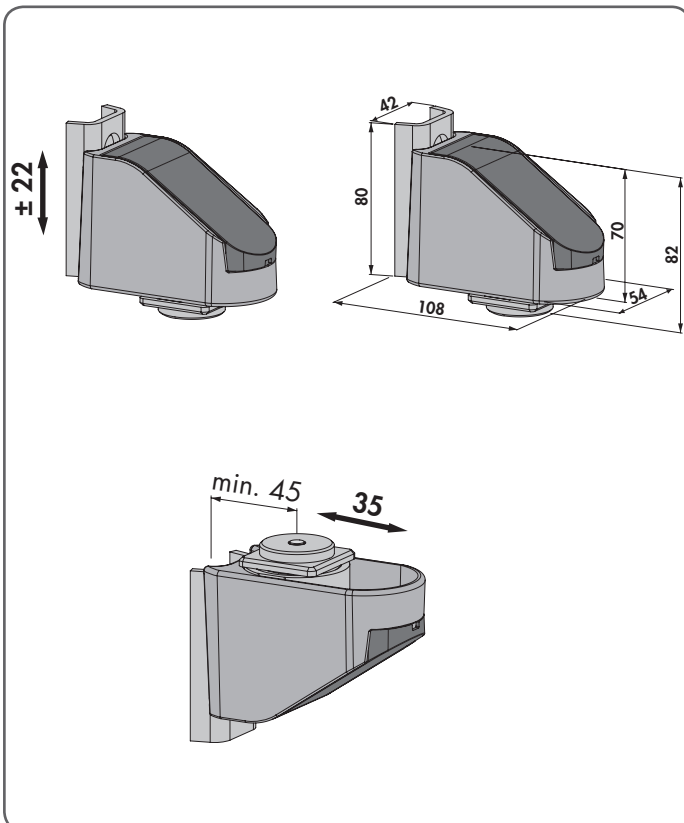

③ MOUNTING

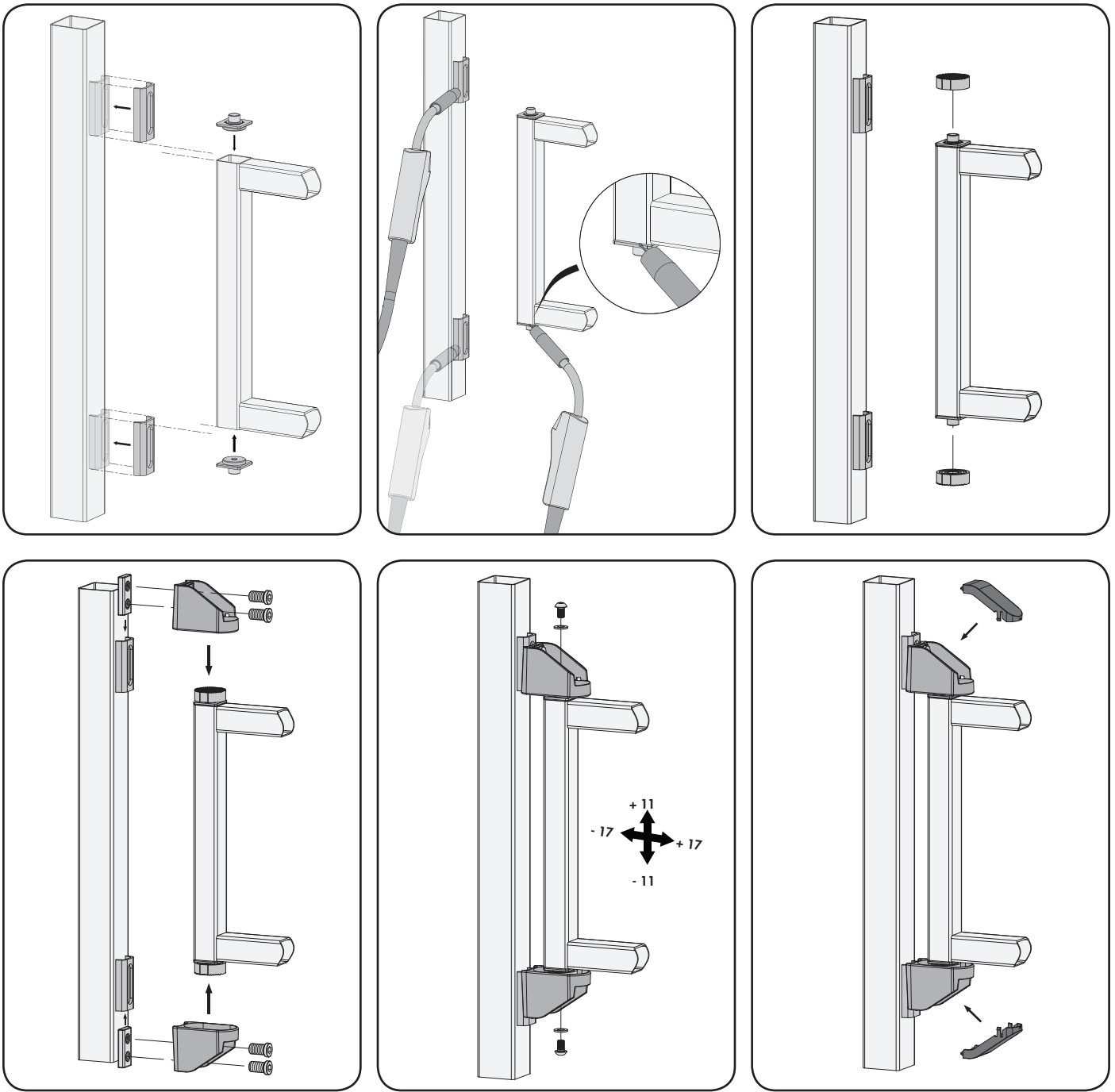

④ MAX. GATE WEIGHT

Max. pull power/hinge	20000 N
Safety Factor	4

Min. Distance between hinges	500 mm
Max gate weight	1019 kg

Distance between hinges in mm	A
Gate length in mm	L
Gate weight in kg	G

	A							
	500	750	1000	1500	2000	2500	3000	3500
500	898	1019	1019	1019	1019	1019	1019	1019
750	565	898	1019	1019	1019	1019	1019	1019
1000	398	648	898	1019	1019	1019	1019	1019
1500	231	398	565	898	1019	1019	1019	1019
2000	148	273	398	648	898	1019	1019	1019
2500	98	198	298	498	698	898	1019	1019
3000	65	148	231	398	565	731	898	1019

LOCINOX[®]
WWW.LOCINOX.COM

Doc. Nr.: MANU-000046



* M A N U - 0 0 0 0 4 6 *

Locinox nv • Mannebeekstraat 21 • B-8790 Waregem • Belgium - Europe
Tel. +32 (0)56 77 27 66 • Fax. +32 (0)56 77 69 26 • E-mail: locinox@locinox.com